

DVD-H1080
DVD-H1080R
DVD-H1080W

DVD Player user manual

imagine the possibilities

Thanks you for purchasing this Samsung product.
To receive more complete service, please register
your product at

www.samsung.com/global/register

precautions

1. Setting up

- Refer to the identification label located on the rear of your player for its proper operating voltage.
- Install your player in a cabinet with adequate ventilation holes. (7~10cm) Do not block ventilation holes on any of the components for air circulation.
- Do not push the disc tray in by hand.
- Do not stack components.
- Be sure to turn all components off before moving the player.
- Before connecting other components to this player, be sure to turn them off.
- Be sure to remove the disc and turn off the player after use, especially if you are not going to use it for a long time.
- The mains plug is used as a disconnect device and shall stay readily operable at any time.

2. For your safety

- This product utilizes a laser. Use of controls or adjustments or performance of procedures other than those specified herein may result in hazardous radiation exposure.
- Do not open covers and do not repair yourself. Refer servicing to qualified personal.

3. Caution

- Your player is not intended for industrial use but for domestic purposes. Use of this product is for personal use only.
- Apparatus shall not be exposed to dripping or splashing and no objects filled with liquids, such as vases, should be placed on the apparatus.
- Exterior influences such as lightning and static electricity can affect normal operation of this player. If this occurs, turn the player off and on again with the POWER button, or disconnect and then reconnect the AC power cord to the AC power outlet. The player will operate normally.

- When condensation forms inside the player due to sharp changes in temperature, the player may not operate correctly. If this occurs, leave the player at room temperature until the inside of the player becomes dry and operational.

4. Disc

- Do not clean disc using record-cleaning sprays, benzene, thinner, or other volatile solvents that may cause damage to the disc surface.
- Do not touch the disc's signal surface. Hold by the edges or by one edge and the hole in the center.
- Wipe the dirt away gently; never wipe a cloth back and forth over the disc.

5. Environmental info

- The battery used in this product contains chemicals that are harmful to the environment.
- So, dispose of batteries in the proper manner, according to federal, state, and local regulations.

The product unit accompanying this user manual is licensed under certain intellectual property rights of certain third parties. This license is limited to private non-commercial use by end-user consumers for licensed contents. No rights are granted for commercial use. The license does not cover any product unit other than this product unit and the license does not extend to any unlicensed product unit or process conforming to ISO/OUR 11172-3 or ISO/OUR 13818-3 used or sold in combination with this product unit. The license only covers the use of this product unit to encode and/or decode audio files conforming to the ISO/OUR 11172-3 or ISO/OUR 13818-3. No rights are granted under this license for product features or functions that do not conform to the ISO/OUR 11172-3 or ISO/OUR 13818-3.

CAUTION: USE OF ANY CONTROLS, ADJUSTMENTS, OR PROCEDURES OTHER THAN SPECIFIED HEREIN MAY RESULT IN HAZARDOUS RADIATION EXPOSURE.

before you start table of content

Accessories



Remote Control



Batteries for Remote Control (AAA Size)

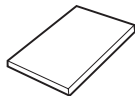

User's Manual



Video/Audio Cable

The accessories which are not supplied are:

- Scart Cable
- Component Cable
- Coaxial Cable.
- HDMI-HDMI Cable.
- HDMI-DVI Cable.

Install Batteries in the Remote control

1. Open the battery cover on the back of the remote control.
2. Insert two AAA batteries.
Make sure that the polarities (+ and -) are aligned correctly.
3. Replace the battery cover.

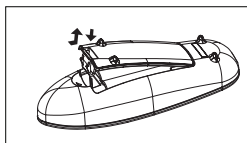

If remote control doesn't operate properly:

- Check the polarity + - of the battery (Dry-Cell)
 - Check if the battery is drained.
 - Check if remote control sensor is blocked by obstacles.
 - Check if there is any fluorescent lighting nearby.
- The rechargeable battery incorporated in this product is not user replaceable.**
- For information on its replacement, please contact your service provider.**

Precautions	2
Before you start	3

Setup

General Features	4
Disc Type and Characteristics	5
Description	6
Tour of the Remote Control.	7

Connections

Choosing a Connection	8
---------------------------------	---

Basic Functions

Playing a Disc	15
Using the Search and Skip Functions	16
Using the Display Function	16
Using the Disc and Title Menu	17
Repeat Play	17
Slow Play	17

Advanced Functions

Adjusting the Aspect Ratio (EZ View)	18
Selecting the Audio Language	18
Selecting the Subtitle Language	19
Changing the Camera Angle	19
Using the Bookmark Function	20
Using the Zoom Function	20
Clips Menu for MP3/WMA/JPEG/MPEG4/CD Audio	20
Folder Selection	21
MP3/WMA/CD Audio Playback	21
MPEG4 Playback	22
Playing media files Using the USB Host Feature	23
CD Ripping	24
Picture CD Playback	25
Picture CD Playback for HD JPEG	26

Changing Setup Menu

Using the Setup Menu.	27
Setting Up the Language Features	27
Setting Up the Audio Options	28
Setting Up the Display Options	29
Setting Up the Parental Control	30
Setting Up the HDMI	32

Reference

Firmware Upgrade.	35
Troubleshooting.	36
Specifications	37

General Features

Excellent Sound

Dolby Digital, a technology developed by Dolby Laboratories, provides crystal clear sound reproduction.

Screen

Both regular and widescreen(16:9) pictures can be viewed.

Slow Motion

An important scene can be viewed in slow motion.

1080p Playback

This player upconverts regular DVDs for playback on 1080p TVs.

Parental Control (DVD)

The parental control allows users to set the level necessary to prohibit children from viewing harmful movies such as those with violence, adult subject matter, etc.

Various On-Screen Menu Functions

You can select various languages (Audio/Subtitle) and screen angles while enjoying movies.

Progressive Scan

Progressive scanning creates an improved picture with double the scan lines of a conventional interlaced picture.

EZ VIEW (DVD)

Easy View enables picture adjustment to match your TV's screen size (16:9 or 4:3).

Digital Photo Viewer (JPEG)

You can view Digital Photos on your TV.

Repeat

You can repeat a song or movie simply by pressing the REPEAT button.

MP3/WMA

This unit can play discs created from MP3/WMA files.

MPEG4

This unit can play MPEG4 formats within an avi file.

CD Ripping

This features lets you to copy audio files from disc to USB device into MP3 format. (Only Audio CD (CD DA)).

HDMI (High Definition Multimedia Interface)

HDMI reduces picture noise by allowing a pure digital video/audio signal path from the player to your TV.

Note

- Discs which cannot be played with this player.
 - DVD-ROM
 - DVD-RAM
 - CD-ROM
 - CDV
 - CDI
 - CVD
 - CDGs play audio only, not graphics.
- Ability to play back may depend on recording conditions.
 - DVD-R, +R
 - CD-RW
 - DVD+RW, -RW (V mode)
- The unit may not play certain CD-R, CD-RW and DVD-R due to the disc type or recording conditions.

COPY PROTECTION

Many DVD discs are encoded with copy protection. Because of this, you should only connect your DVD player directly to your TV, not to a VCR. Connecting to a VCR results in a distorted picture from copy-protected DVD discs.

This product incorporates copyright protection technology that is protected by methods claims of certain U.S. patents and other intellectual property rights owned by Macrovision Corporation and other rights owners. Use of this copyright protection technology must be authorized by Macrovision Corporation, and is intended for home and other limited viewing uses only unless otherwise authorized by Macrovision Corporation. Reverse engineering or disassembly is prohibited.



PROGRESSIVE SCAN OUTPUTS

(576p,720p,1080p)







“CONSUMERS SHOULD NOTE THAT NOT ALL HIGH DEFINITION TELEVISION SETS ARE FULLY COMPATIBLE WITH THIS PRODUCT AND MAY CAUSE ARTIFACTS TO BE DISPLAYED IN THE PICTURE, IN CASE OF 576, 720, 1080 PROGRESSIVE SCAN PICTURE PROBLEMS, IT IS RECOMMENDED THAT THE USER SWITCH THE CONNECTION TO THE ‘STANDARD DEFINITION’ OUTPUT. IF THERE ARE QUESTIONS REGARDING YOUR TV SET COMPATIBILITY WITH THIS MODEL 576p, 720p, 1080p DVD PLAYER, PLEASE CONTACT SAMSUNG’S CUSTOMER SERVICE CENTER.”

Disc Type and Characteristics

This DVD player is capable of playing the following types of discs with the corresponding logos:

Disc Types (Logos)	Recording Types	Disc Size	Max. Playing Time	Characteristic
	Audio + Video	12 Cm	Single-sided 240 min. Double-sided 480 min	<ul style="list-style-type: none"> - DVD contains excellent sound and video due to Dolby Digital and MPEG-2 system. - Various screen and audio functions can be easily selected through the on-screen menu.
		8 Cm	Single-sided 80 min. Double-sided 160 min.	
	Audio	12 Cm	74 min.	<ul style="list-style-type: none"> - CD is recorded as a Digital Signal with better audio quality, less distortion and less deterioration of audio quality over time.
		8 Cm	20 min.	

Disc Markings

	Play Region Number
	PAL broadcast system in U.K, France, Germany, etc.
	Dolby Digital disc
	Stereo disc
	Digital Audio disc
	DTS disc
	MP3 disc

You must only insert one DVD disc at a time. Inserting two or more discs will not allow to play them back and it may cause damage to the DVD player.

Region Number

Both the DVD player and the discs are coded by region. These regional codes must match in order for the disc to play. If the codes do not match, the disc will not play.

The Region Number for this player is described on the bottom panel of the player.

DivX Certification



DivX, DivX Certified, and associated logos are trademarks of DivXNetworks, Inc and are used under license

Description

Front Panel Controls

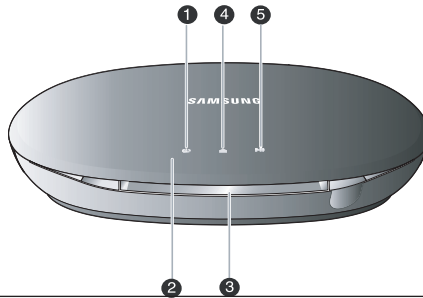

1. **STANDBY/ON (⏻)**
When STANDBY/ON is pressed on, the indicator goes out and the player is turned on.
2. **STANDBY Indicator**
When the unit is first plugged in, the indicator lights.
3. **DISC TRAY**
Place the disc here.
4. **OPEN/CLOSE/Stop (⏮)**
Press to open and close the disc tray, Stops disc play.
5. **PLAY/PAUSE (▶||)**
Begin or pause disc play.

Rear Panel

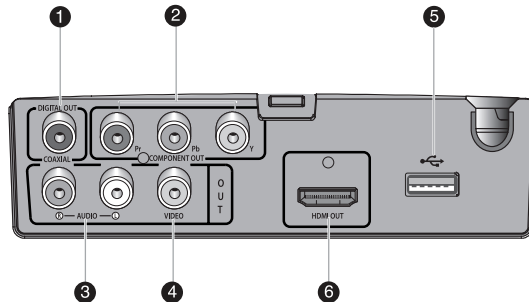

1. **DIGITAL AUDIO OUT JACKS**
 - Use coaxial digital cable to connect to a compatible Dolby Digital receiver.
 - Use coaxial digital cable to connect to an A/V Amplifier that contains a Dolby Digital, MPEG2 or DTS decoder.
2. **COMPONENT VIDEO OUT JACKS**
 - Use these jacks if you have a TV with Component Video in jacks. These jacks provide P_R, P_B and Y video.
 - If P-SCAN Video Output is selected in Setup Menu, progressive scan mode will work.
 - If I-SCAN Video Output is selected in Setup Menu, interlaced scan mode will work.
3. **AUDIO OUT JACKS**
 - Connect to the Audio input jacks of your television or audio/video receiver.
4. **VIDEO OUT JACK**
 - Use a video cable to connect to the Video input jack on your television.
5. **USB Host**
 - Connect digital still camera, MP3 player, memory stick, Card reader, or another removable storage devices.
6. **HDMI OUT JACK**
 - Use the HDMI cable to connect this jack to the HDMI jack on your television for the best quality picture.
 - If an HDMI cable is connected to an HDMI-compatible TV, HDMI will be output automatically within 10 seconds.

Note

- Consult your TV User's Manual to find out if your TV supports Progressive Scan (P-SCAN). If Progressive Scan is supported, follow the TV User's Manual regarding Progressive Scan settings in the TV's menu system.
- The HDMI output of this unit can be connected to a DVI jack on a TV or other device using a conversion adapter. In this case, it is necessary to use a TV or display with an HDCP-compatible DVI input.
- There may be no image output if the DVD player is connected to a TV or display that is not compatible with the above format.
- Refer to the TV's instruction manual for detailed information regarding the HDMI terminal.
- See pages 29 ~ 30 to get more information on how to use the setup menu.

Tour of the Remote Control

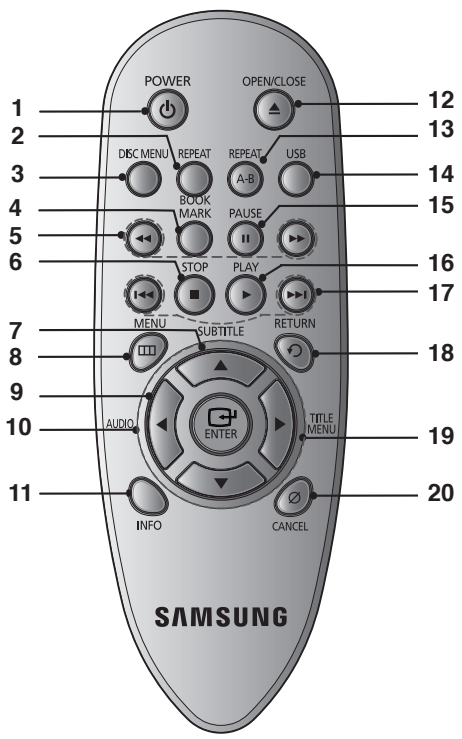

- 1. DVD Power Button**
Turns the power on or off.
- 2. REPEAT Button**
Allows you to repeat play a title, chapter, track or disc
- 3. DISC MENU Button**
Brings up the Disc menu.
- 4. Bookmark Button**
- 5. SEARCH Buttons (◀ / ▶)**
Allow you to search forward/backward through a disc.
- 6. STOP Button (■)**
- 7. SUBTITLE (▲) Button**
- 8. MENU Button**
Brings up the DVD player's menu.
- 9. AUDIO (◀) Button**
Use this button to access various audio functions on a disc.
- 10. ENTER/▲/▼, ◀/▶ Buttons**
This button functions as a toggle switch.
- 11. INFO Button**
Displays the current disc mode.
- 12. OPEN/CLOSE (▲) Button**
To open and close the disc tray.
- 13. REPEAT A-B Button**
Allows you to repeat play a chosen section (A-B) on a disc.
- 14. USB button**
- 15. PAUSE Button (||)**
Pause disc play.
- 16. PLAY Button (▶)**
Begin disc play.
- 17. SKIP Buttons (◀◀ / ▶▶)**
Use to skip the title, chapter or track.
- 18. RETURN Button**
Returns to a previous menu.
- 19. TITLE MENU (▶) Button**
Brings up the Title menu.
- 20. CANCEL Button**
Use to remove menus or status displays from the screen.

connections

Choosing a Connection

The following shows examples of connections commonly used to connect the DVD player with a TV and other components.

Before Connecting the DVD Player

- Always turn off the DVD player, TV, and other components before you connect or disconnect any cables.
- Refer to the user's manual of the additional components you are connecting for more information on those particular components.

Connecting to a TV (VIDEO CVBS)

1

Using video/audio cables, connect the **VIDEO (yellow)/AUDIO (red and white) OUT** terminals on the rear of the DVD player to the **VIDEO (yellow)/AUDIO (red and white) IN** terminals of TV.

2

Turn on the DVD player and TV.

3

Press the input selector on your TV remote control until the Video signal from the DVD player appears on the TV screen.

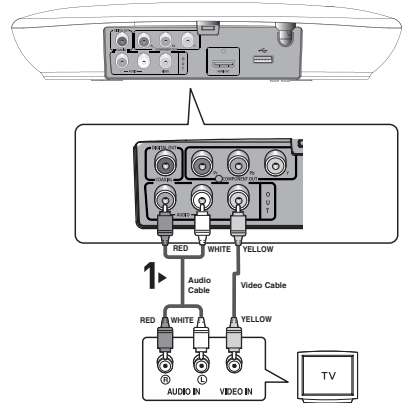

Note

- **Noise may be generated if the audio cable is too close to the power cable.**
- If you want to connect to an Amplifier, please refer to the Amplifier connection page. (See pages 13 to 14)
- The number and position of terminals can vary depending on your TV set. Please refer to the user's manual of the TV.
- If there is one audio input terminal on the TV, connect it to the [AUDIO OUT][left] (white) terminal of the DVD player.

Connection to a TV (Interlace)

- Connecting to your TV using Component video cables.
- You will enjoy high quality and accurate color reproduction images. Component video separates the picture element into black and white(Y), blue(P_B), red(P_R) signals to present clear and clean images. (Audio signals are delivered through the audio output.)

1

Using component video cables (not included), connect the **COMPONENT VIDEO OUT** terminal on the rear of the DVD player to the **COMPONENT IN** terminal of TV.

2

Using the audio cables, connect the **AUDIO (red and white) OUT** terminals on the rear of the DVD player to the **AUDIO (red and white) IN** terminals of TV. Turn on the DVD player and TV.

3

Press the input selector on your TV remote control until the Component signal from the DVD player appears on the TV screen.

4

Set the Video Output to **I-SCAN** in the Display Setup menu. (See pages 29-30)

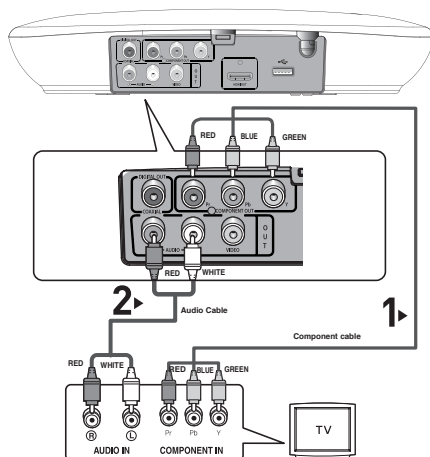

Note

- If you want to connect to an Amplifier, please refer to the Amplifier connection page. (See pages 13 to 14)
- The component terminal of TV can be marked by "R-Y, B-Y, Y" or "Cr, Cb, Y" instead of "P_R, P_B, Y" depending on the manufacturer. The number and position of terminals can vary depending on the TV set. Please refer to the user's manual of the TV.

connections

Connection to a TV (Progressive)

1

Using component video cables (not included), connect the **COMPONENT VIDEO OUT** terminal on the rear of the DVD player to the **COMPONENT IN** terminal of TV.

2

Using the audio cables, connect the **AUDIO (red and white) OUT** terminals on the rear of the DVD player to the **AUDIO (red and white) IN** terminals of TV. Turn on the DVD player and TV.

3

Press the input selector on your TV remote control until the Component signal from the DVD player appears on the TV screen.

4

Set the Video Output to **P-SCAN** in the Display Setup menu. (See pages 29-30)

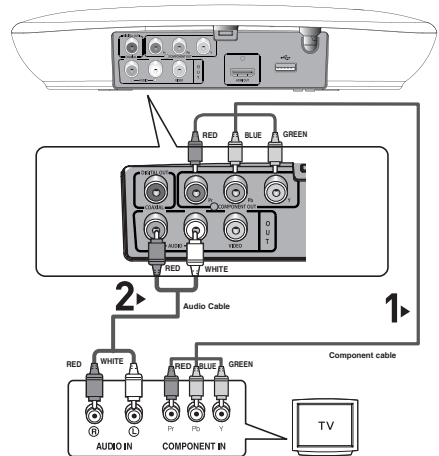

To see the progressive video output,

- Consult your TV User's Manual to find out if your TV supports Progressive Scan. If Progressive Scan is supported, follow the TV User's Manual regarding Progressive Scan settings in the TV's menu system.
- Depending on your TV, the connection method may differ from the illustration above.

Note

- What is "Progressive Scan"?
Progressive scan has twice as many scanning lines as the interlace output method has. Progressive scanning method can provide better and clearer picture quality.

Connecting to a TV with DVI Jack

1

Using an HDMI-DVI cable (not included), connect the **HDMI OUT** terminal on the rear of the DVD player to the **DVI IN** terminal of your TV.

2

Using the audio cables, connect the **AUDIO (red and white) OUT** terminals on the rear of the DVD player to the **AUDIO (red and white) IN** terminals of your TV. Turn on the DVD player and TV.

3

Press the input selector on your TV remote control until the DVI signal from the DVD player appears on your TV screen.

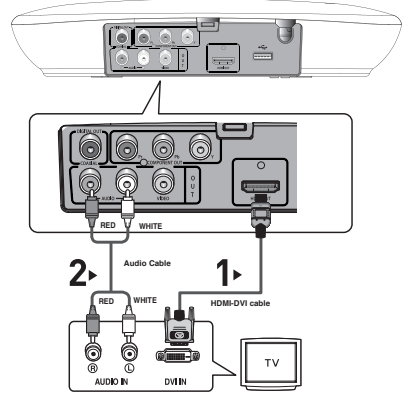

Connecting to a TV with HDMI Jack

1

Using the HDMI-HDMI cable connect the **HDMI OUT** terminal on the rear of the DVD player to the **HDMI IN** terminal of your TV.

2

Press the input selector on your TV remote control until the HDMI signal from the DVD player appears on your TV screen.

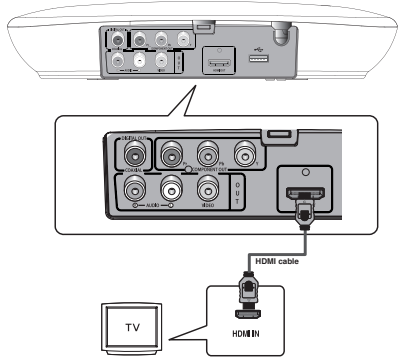

HDMI VIDEO Specifications

- Depending on your TV, certain HDMI output resolutions may not work.
- Please refer to the user's manual of your TV.
- If HDMI or HDMI-DVI cable is plugged into TV, the DVD player's output is set to HDMI/DVI within 10 -seconds.
- If you set the HDMI output resolution 720p, 1080p or 1080i, HDMI output provides better picture -quality.
- If you connect an HDMI cable between Samsung TV and this DVD player, you can operate this DVD player using your TV remote control. This is only available with Samsung TVs that support Anynet+(HDMI-CEC). (See page 32).
- If your TV has an *Anynet+* logo, then it will *Anynet+* Supports the Anynet+ Function.

connections

- **HDMI (High Definition Multimedia Interface)**

HDMI is an interface to enable the digital transmission of video and audio data with just a single connector.

Using HDMI, the DVD player transmits a digital video and audio signal and displays a vivid picture on a TV having an HDMI input jack.

- **HDMI connection description**

HDMI connector - Both uncompressed video data and digital audio data (LPCM or Bit Stream data).

- Though the player uses a HDMI cable, the player outputs only a pure digital signal to the TV.
- If TV does not support HDCP (High-bandwidth Digital content protection), snow noise appears on the screen.

- **Why does Samsung use HDMI?**

Analog TVs require an analog video/audio signal. However, when playing a DVD, the data transmitted to a TV is digital. Therefore either a digital-to-analog converter (in the DVD player) or an analog-to-digital converter (in the TV) is required. During this conversion, the picture quality is degraded due to noise and signal loss. DVI technology is superior because it requires no D/A conversion and is a pure digital signal from the player to your TV.

- **What is the HDCP?**

HDCP (High-bandwidth Digital Content Protection) is a system for protecting DVD content outputted via DVI from being copied. It provides a secure digital link between a video source (PC, DVD, etc) and a display device (TV, projector . etc). Content is encrypted at the source device to prevent unauthorized

Connection to an Audio System (2 Channel Amplifier)

1

Using the audio cables, connect the **AUDIO (red and white) OUT** terminals on the rear of the DVD player to the **AUDIO (red and white) IN** terminals of the Amplifier.

2

Using the video signal cable(s), connect the **VIDEO** or **COMPONENT OUT** terminals on the rear of the DVD player to the **VIDEO** or **COMPONENT IN** terminal of your TV as described on pages 8 to 11.

3

Turn on the DVD player, TV, and Amplifier.

4

Press the input select button of the Amplifier to select **external input** in order to hear sound from the DVD player.

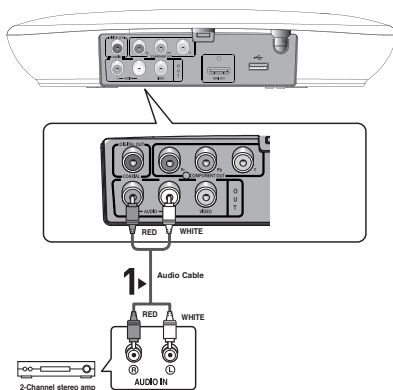

Note

- **Please turn the volume down when you turn on the Amplifier. Sudden loud sound may cause damage to the speakers or to your hearing.**
- Please set the audio in the menu screen according to the Amplifier. (See pages 28 to 29)
- The position of terminals can vary depending on the Amplifier. Please refer to the user's manual of the Amplifier.

connections

Connection to an Audio System (Dolby Digital, MPEG2 or DTS Amplifier)

1

If using a coaxial cable (not included), connect the **DIGITAL AUDIO OUT (COAXIAL)** terminal on the rear of the DVD player to the **DIGITAL AUDIO IN (COAXIAL)** terminal of the Amplifier.

2

Using the video signal cable(s), connect the **VIDEO**, **COMPONENT** or **HDMI OUT** terminals on the rear of the DVD player to the **VIDEO**, **COMPONENT** or **DVI IN** terminals of your TV as described on pages 8 to 11.

3

Turn on the DVD player, TV, and Amplifier.

4

Press the input select button of the Amplifier to select **external input** in order to hear sound from the DVD player. Refer to your Amplifier's user manual to set the Amplifier's audio input.

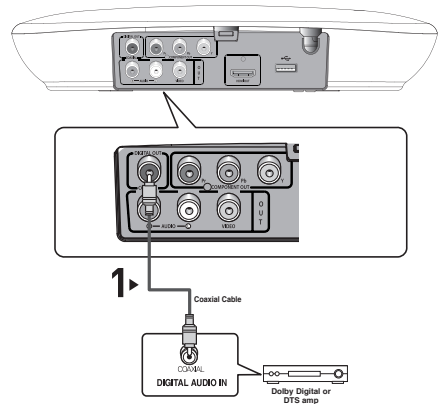

Note

- Please turn the volume down when you turn on the Amplifier. Sudden loud sound may cause damage to the speakers or to your hearing.
- Please set the audio in the menu screen according to the Amplifier. (See pages 28 to 29)
- The position of terminals can vary depending on the Amplifier. Please refer to the user's manual of the Amplifier.

basic functions

Playing a Disc

Before Play

- Turn on your TV and set it to the correct Video Input by pressing TV/VIDEO button on the TV remote control.
- If you connected an external Audio System, turn on your Audio System and set it to the correct Audio Input.

After plugging in the player, the first time you press the DVD **POWER** button, this screen comes up: If you want to select a language, Press the ▲/▼ buttons, and then press the **ENTER** button. (This screen will only appear when you plug in the player for the first time.)

If the language for the startup screen is not set, the settings may change whenever you turn the power on or off. Therefore, make sure that you select the language you want to use.

Once you select a menu language, you can change it by pressing the (▶||) button on the front panel of the unit for more than 5 seconds with no disc in the unit. Then the **SELECT MENU LANGUAGE** window appears again where you can reset your preferred language.



Playback

1. Press the **OPEN/CLOSE** (▲) button. The **STANDBY** indicator light goes out and the tray opens.
2. Place a disc gently into the tray with the disc's label facing up.
3. Press the **PLAY** (▶) button or **OPEN/ CLOSE** (▲) button to close the disc tray. When you stop disc play, the player remembers where you stopped, so when you press **PLAY** (▶) button again, it will pick up where you left off.

4. Stopping Play

Press the **STOP** (■) button during play.

5. Removing Disc

Press the **OPEN/CLOSE** (▲) button.

6. Pausing Play

Press the **PAUSE** (||) button on the remote control during play.

- Screen stops, no sound.

To resume, press the **PLAY** (▶) button once again.

7. Slow Motion Play

Press the **SEARCH** (◀▶) button to choose the play speed between 1/2, 1/4 1/8 and 1/16 the of normal speed during **PAUSE** mode.

- No sound is heard during slow mode.

- Press the **PLAY** (▶) button to resume normal play.

8. Step Motion Play (Except CD)

Press the **SKIP** (▶▶) button on the remote control during **PAUSE** mode.

- Each time the button is pressed, a new frame will appear.

- No sound is heard during **STEP** mode.

- Press the **PLAY** (▶) button to resume normal play.

- You can only perform step motion play in the forward direction.

Note

- If the player is left in the stop mode for more than one minute without any user interaction, a screen saver will be activated. Press the **PLAY** (▶) button to resume normal play.
- If the player is left in the stop mode for more than about 30 minutes, the power will automatically shut off.(Automatic Power-Off Function)
- If the player is left for about 5 minutes in pause mode, it will stop.
- This (⊙) icon indicates an invalid button press.

basic functions

Using the Search and Skip Functions

During play, you can search quickly through a chapter or track, and use the skip function to jump to the next selection.

Searching through a Chapter or Track

During play, press the **SEARCH** (◀◀ or ▶▶) button on the remote control for more than 1 second.

DVD	2X, 4X, 64X, 128X
CD	2X, 4X, 8X

Note

- The speed marked in this function may be different from the actual playback speed.
- No sound is hearing during search mode (Except CD).

Skipping Tracks

During play, press the **SKIP** (◀◀ or ▶▶) button.









- When playing a DVD, if you press the **SKIP** (▶▶) button, it moves to the next chapter. If you press the **SKIP** (◀◀) button, it moves to the beginning of the chapter. One more press makes it move to the beginning of the previous chapter.
- When playing a CD in Menu Off mode, if you press the **SKIP** (▶▶) button, it moves to the next track. If you press the **SKIP** (◀◀) button, it moves to the beginning of the track. One more press makes it move to the beginning of the previous track.

Using the Display Function

When Playing a DVD/MPEG4

1. During play, press the **INFO** button on the remote control.
2. Press the ▲/▼ buttons to select the desired item.
3. Press the ◀/▶ buttons to make the desired setup and then press the **ENTER** button.
4. To make the screen disappear, press the **INFO** button again.

Note

	To access the desired title when there is more than one in the disc. For example, if there is more than one movie on a DVD, each movie will be identified.
	Most DVD discs are recorded in chapters so that you can quickly find a specific passage (similar to tracks on an audio CD).
	Allows playback of the film from a desired time. You must enter the starting time as a reference. The time search function does not operate on some discs
	Refers to the film's soundtrack language. In the example, the soundtrack is played in English 5.1CH. A DVD disc can have up to eight different soundtracks.
	Refers to the subtitle languages available in the disc. You will be able to choose the subtitle languages or, if you prefer, turn them off from the screen. A DVD disc can have up to 32 different subtitles
	The EZ View function is used for changing the aspect ratio in DVD.
	This button has function as shortcut. Press enter to activate the Zoom function.
	To access the desired Angle function. Some DVD discs have more than one recorded angle.

Using the Disc and Title Menu

Using the Disc Menu

1. During the playback of a DVD disc, press the **DISC MENU** button on the remote control.
2. Press the **▲/▼** buttons for navigation/change selection, then-press **ENTER** button.
3. To make the screen disappear, press the **RETURN** or **DISC MENU** button again.



Note

- The disc menu may not work on certain disc types.
- You can also use the Disc Menu, using the DISC MENU button on the remote control.

Using the Title Menu

1. During the playback of a DVD disc, press the **►/TITLE MENU** button on the remote control.
2. Press the **▲/▼** buttons to select for navigation/change selection, then press the **ENTER** button.
3. To make the screen disappear, press the **RETURN** button again.

Note

- The disc menu may not work on certain disc types.
- Title Menu will only be displayed if there are at least two titles in the disc.

Repeat Play

Press the REPEAT button to change playback mode.

When playing a DVD

- DVD repeats play by chapter or title.
- Chapter : repeats the chapter that is playing.
- Title : repeats the title that is playing.
- Disc : repeats the disc that is playing.
- Off



Using the A-B Repeat function

1. Press the REPEAT A-B button on the remote control at the point where you want repeat play to start (A).
2. Press the REPEAT A-B button on the remote control at the point where you want the repeat play to stop (AB).

DVD



Note

- A-B REPEAT allows you to set point (AB) directly after point (A) has been set.
- The disc menu may not work on certain disc types.

Slow Play

This feature allows you to slowly repeat scenes containing sports, dancing, musical instruments being played etc., so you can study them more closely.

When playing a DVD

1. During play, press the **PAUSE (||)** button.
2. Press the **SEARCH (◀ / ▶)** button to choose the play speed between 1/2, 1/4, 1/8 and 1/16 of normal during PAUSE mode.

advanced functions

Adjusting the Aspect Ratio (EZ View)

To play back using aspect ratio (DVD)

1. During play, press the INFO button on the remote control.
2. Press the ▲/▼ buttons to select  icon. Press the ◀/▶ buttons, the screen size change when these button is pressed.
3. To make the screen disappear, press the INFO button again.

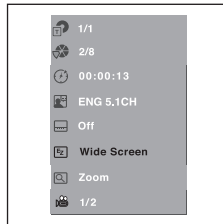

If you are using a 16:9 TV

For 16:9 aspect ratio discs

- **WIDE SCREEN**
Displays the content of the DVD title in 16:9 aspect ratio.
- **SCREEN FIT**
The top and bottom portions of the screen are cut off.
When playing a 2.35:1 aspect ratio disc, the black bars at the top and bottom of the screen will disappear. The picture will look vertically stretched. (Depending on the type of disc, the black bars may not disappear completely.)
- **ZOOM FIT**
The top, bottom, left and right of the screen are cut off and the central portion of the screen is enlarge

For 4:3 aspect ratio discs

- **Normal Wide**
Displays the content of the DVD title in 16:9 aspect ratio. The picture will look horizontally stretched.
- **SCREEN FIT**
The top and bottom portions of the screen are cut off and the full screen appears.
The picture will look vertically stretched.
- **ZOOM FIT**
The top, bottom, left and right portions of the screen are cut off and the central portion of the screen is enlarged.
- **Vertical Fit**
When a 4:3 DVD is viewed on a 16:9 TV, black bars will appear at the left and right of the screen in order to prevent the picture from looking horizontally stretched.

If you are using a 4:3 TV

For 16:9 aspect ratio discs

- **4:3 Letter Box**
Displays the content of the DVD title in 16:9 aspect ratio. The black bars will appear at the top and bottom of the screen.
- **4:3 Pan Scan**
The left and right portions of the screen are cut off and the central portion of the 16:9 screen is displayed.
- **SCREEN FIT**
The top and bottom portions of the screen are cut off and a full screen appears. The picture will look vertically stretched.
- **ZOOM FIT**
The top, bottom, left and right of the screen are cut off and the central portion of the screen is enlarged.

For 4:3 aspect ratio discs

- **Normal Screen**
Displays the content of the DVD title in 4:3 aspect ratio.
- **SCREEN FIT**
The top and bottom portions of the screen are cut off and the full screen appears. The picture will look vertically stretched.
- **ZOOM FIT**
The top, bottom, left and right portions of the screen are cut off and the central portion of the screen is enlarged.

Note

This function may behave differently depending on the type of disc.

Selecting the Audio Language

You can select a desired audio language quickly and easily with the ◀/AUDIO button.

Using the ◀/AUDIO button (DVD/MPEG4)

1. Press the ◀/AUDIO button. The Audio changes when the button is pressed repeatedly. The audio languages are represented by abbreviations.

DVD



Press ◀/AUDIO button at remote control repeatedly to select the desired Audio on MPEG4 then press the ENTER .

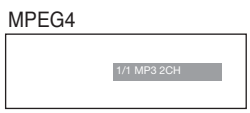

Note

- This function depends on audio languages encoded on the disc and may not work.
- A DVD disc can contain up to 8 audio languages.
- To have the same audio language come up whenever you play a DVD; Refer to “Using the Audio Language” on page 28.
- Possible warning messages that may appear if the device (TV) that connected to the HDMI can't support RAW digital audio.

Note

- You have to change the desired subtitle in the Disc Menu, according to discs. Press the DISC MENU button.
- This function depends on what subtitles are encoded on the disc and may not work on all DVDs.
- A DVD disc can contain up to 32 subtitle languages.
- To have the same subtitle language come up whenever you play a DVD; Refer to “Using the Subtitle Language” on page 28.

Selecting the Subtitle Language

You can select a desired subtitle quickly and easily with the ▲/SUBTITLE button.

Using the ▲/SUBTITLE button (DVD/MPEG4)

1. Press the ▲/SUBTITLE button. The subtitle languages are represented by abbreviations. The subtitle changes when the button is pressed repeatedly.

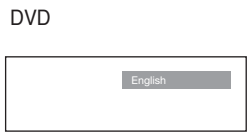

Repeatedly Press ▲/SUBTITLE button on the remote control to select the desired subtitle language on MPEG4 then press ENTER .

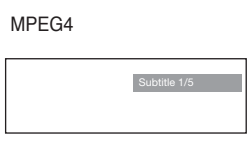

Changing the Camera Angle

When a DVD contains multiple angles of a particular scene, you can use the ANGLE function.

Using the ANGLE function (DVD)

- If the disc contains multiple angles, the ANGLE appears on the screen.
1. During play, press the INFO button on the remote control.
 2. Press the ▲/▼ buttons to select  icon.
 3. Press the ◀/▶ buttons on the remote control to select the desired angle.
 4. To make the screen disappear, press the INFO button again.



Note

- If the disc has only one angle, this feature won't work. Currently, very few discs have this feature.
- Depending on the disc, these functions may not work.

advanced functions

Using the Bookmark Function

This feature lets you bookmark sections of a DVD so you can quickly find them at a later time.

Using the Bookmark Function (DVD)

1. During play, press the Bookmark button on the remote control.
2. When You reach the scene you want to mark, press the ENTER button. Up to 12 scenes may be marked at a time.

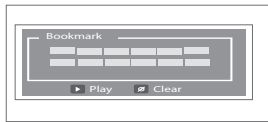

Note

- These functions may not Work on certain disc types.

Recalling a Marked Scene

1. During play,press the Bookmark button on the remote control.
2. Press the ◀/▶/▲/▼ buttons to select a marked scene.
3. Press the **PLAY** (▶) button to skip to the marked scene.



Clearing a Bookmark

1. During play,press the Bookmark button on the remote control.
2. Press the ◀/▶/▲/▼ buttons to select a marked scene.
3. Press the **CANCEL** button to delete a bookmark number.



Using the Zoom Function

Using the Zoom Function (DVD)

1. During play, press the **INFO** button on the remote control.
2. Press the ▲/▼ buttons to select  icon, then press the **ENTER** button to zoom in 2x, 3x, 4x.
3. To make the screen disappear, press the **INFO** button again.

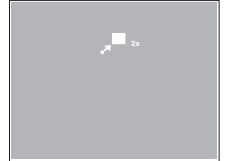

Clips Menu for MP3/WMA/JPEG/MPEG4/CD Audio

CD Audio or discs with MP3/WMA/JPEG/MPEG4 contain individual songs and/or pictures that will be organized into folders on this unit as shown below.They are similar to how you use your computer to put files into different folders.

- Open the disc tray.
- Place the disc on the tray.
- Close the tray.
- The tray closes and this screen displays.



-  : Current Playback Mode : There are four modes.
They can be selected in order by pressing the REPEAT button.
 - Off : Normal Playback.
 - Track : Repeats the current track.
 - Folder : Repeats the current folder.
 - Random : Files in the disc will be played in random order.

- ■ : STOP icon
- ▶ : PLAY file icon
- [MP3] : MP3 file icon
- [WMA] : WMA file icon
- [JPG] : JPEG file icon
- [AVI] : AVI file icon
- [CD] : CD Audio file icon
- [Folder] : Folder icon
- [Current Folder] : Current Folder icon

CD-R MP3/WMA file

When you record MP3 or WMA files on CD-R, please refer to the following.

- Your MP3 or WMA files should be ISO 9660 or JOLIET format.

ISO 9660 format and Joliet MP3 or WMA files are compatible with Microsoft's DOS and Windows, and with Apple's Mac. This format is the most widely used.

- When naming your MP3 or WMA files, do not exceed 8 characters, and enter ".mp3, .wma" as the file extension. General name format : Title.mp3. or Title.wma. When composing your title, make sure that you use 8 characters or less, have no spaces in the name, and avoid the use of special characters including: (,/, \, =, +).

- Use a decompression transfer rate of at least 128 Kbps when recording MP3 files.

Sound quality with MP3 files basically depends on the rate of compression/decompression you choose. Getting CD audio sound requires an analog/digital sampling rate, that is conversion to MP3 format, of at least 128 Kbps and up to 160 Kbps. However, choosing higher rates, like 192 Kbps or more, only rarely give better sound quality. Conversely, files with decompression rates below 128 Kbps will not be played properly.

- Use a decompression transfer rate of at least 64Kbps when recording WMA files.

Sound quality with WMA files basically depends on the rate of compression/decompression you choose. Getting CD audio sound requires an analog/digital sampling rate, that is conversion to WMA format, of at least 64Kbps and up to 192Kbps. Conversely, files with decompression rates below 64Kbps or over 192Kbps will not be played properly.

- Do not try recording copyright protected MP3 files. Certain "secured" files are encrypted and code protected to prevent illegal copying. These files are of the following types: Windows MediaTM (registered trade mark of Microsoft Inc) and SDMITM (registered trade mark of The SDMI Foundation). You cannot copy such files.

- Important: The above recommendations cannot be taken as a guarantee that the DVD player will play MP3 recordings, or as an assurance of sound quality. You should note that certain technologies and methods for MP3 file recording on CD-Rs prevent optimal playback of these files on your DVD player (degraded sound quality and in some cases, inability of the player to read the files).
- This unit can play a maximum of 500 files and 500 folders per disc.

Folder Selection

- To select the Parent Folder
Press the RETURN button to go to parent folder, or press the ▲/▼ buttons to select ".." and press ENTER to go to the parent folder.

MP3/WMA/CD Audio Playback

1. Open the disc tray. Place the disc on the tray. Close the tray.
 - Only one kind of file is played back when a disc or a folder contains both MP3 and WMA files.
2. Press the ▲/▼ buttons to select a song file. Press ENTER to begin playback of the song file.



Repeat/Random playback

Press the REPEAT button to change the playback mode. There are four modes: Off, Track, Folder and Random.

- Off: Normal Playback
- Track: Repeats the current song file.
- Folder: Repeats the song files which have the same extension in the current folder.
- Random: Song files which have the same extension will be played in random order.

To resume normal play, press the CANCEL button.

advanced functions

MPEG4 Playback

MPEG4 Play Function

AVI files are used to contain the audio and video data. Only AVI format files with the ".avi" extensions can be played.

1. Open the disc tray. Place the disc on the tray.
Close the tray.
2. Press the ▲/▼ or ◀/▶ buttons to select an avi file (DivX/XviD) and then press ENTER button.



Repeat playback

Press the REPEAT button to change playback mode. There are 3 modes: - Off, Folder and Track.

- Folder : repeats the AVI files which have the same extension in the current folder.
- Track : repeats the track that is playing.

MPEG4 Function Description

Function	Description	Reference Page
Skip (◀◀ or ▶▶)	During Play, press the ◀◀ or ▶▶ button, it moves forward or backward 5 minutes.	-
Search (◀◀ or ▶▶)	During play, press the SEARCH (◀◀ or ▶▶) button and press again to search at a faster speed. Allows you to search at a faster speed in an AVI file (2X, 4X, 8X)	-
Slow Motion Play	Allows you to search at a slower speed in an AVI file. (1/2X, 1/4X, 1/8X, and 1/16X)	P 15
ZOOM	2X/ 3X/ 4X/ Normal in order	P 20

- These functions may not work depending on MPEG4 file.

CD-R AVI file

This unit can play the following video compression formats within the AVI file format:

- DivX 3.11 contents
- DivX 4 contents (Based on MPEG-4 Simple Profile)
- DivX 5 contents (MPEG-4 simple profile plus additional features such as bi-directional frames. Qpel and GMC are also supported.)
- XviD MPEG-4 compliant Contents.

DVD-RW & DVD+R

Format that support for DivX file :

- Basic DivX format DivX3.11 / 4.12/ 5.x
- Xvid (MPEG-4 compliant video codec) and DivX Pro
- File format : *.avi, *.div, *.divx.

This unit supports all resolutions up to maximum below.

DivX3.11 & DivX4 & Xvid	DivX5
Bit rate may fluctuate: Device may skip decoding the high bit rate portions and begin decoding again when bit rate returns to normal	720 x 480 @30fps 720 x 576 @25fps : Maximum bit rate :4Mbps

Possible warning messages that may appear when trying to play DivX/AVI files are :

1. No Authorization
 - File with bad registration code.
2. Unsupported Codec
 - Files with certain Codec Types, Versions (ex. MP4, AFS and other proprietary codecs) are not supported by this player.
3. Unsupported Resolution
 - Files containing resolutions higher than the player's specification are not supported.

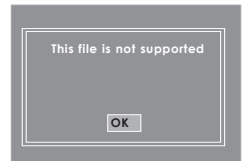

Note

- The resolution that can be supported by DVD-H1080 model up to 720 x 480 @30 frames/720 x 576 @25 frames.
- This unit supports CD-R/RW written in MPEG4 in accordance with the "ISO9660 format".

Playing Media Files Using the USB Host feature

You can enjoy the media files such as pictures, movies and tunes saved in an MP3 player, USB memory or digital camera in high audio by connecting the storage device to the USB port of the DVD Player.

Using the USB HOST feature

1. Connect the USB device to the USB port on the rear of the unit.
2. If there is partition on USB, Press the ◀/▶ button to select the one of partitions from USB and Press **ENTER**.



3. Press the ▲/▼ buttons to select a file in USB. Press **ENTER** to Open file.



Note

- Each time the USB button on the remote control is pressed, a frame of the USB device selection will appear.
- " Press USB to select device" appear at the top left corner for a moment.
- USB MENU screen appears on the TV screen and the saved file is played.

Safe USB Removal

To prevent damage to the memory stored in the USB device, perform safe removal before disconnecting the USB cable.

- Press the STOP (■) button.
- Remove the USB cable.

Skip Forward/Back

During playback, press the (◀▶) button.

- When there is more than one file, when you press the ▶▶ button, the next file is selected
- When there is more than one file, when you press the ◀◀ button, the previous file is selected

Fast playback

To play back the disc at a faster speed, press (◀◀ / ▶▶) during playback.

- Each time you press either button, the playback speed will change as follows : 2x → 4x → 8x.

Compatible Devices

1. USB devices that support USB Mass Storage v1.0. (USB devices that operate as a removable disk in Windows (2000 or later) without additional driver installation.)
2. MP3 Player: Flash type MP3 player.
3. Digital camera: Cameras that support USB Mass Storage v1.0.
 - Cameras that operate as a removable disk in Windows (2000 or later) without additional driver installation.
4. USB Flash Drive: Devices that support USB2.0 or USB1.1
 - You may experience a difference in playback quality when you connect a USB1.1 device.
5. USB card Reader: One slot USB card reader and Multi slot USB card reader
 - The USB card reader may not be supported dependent upon manufacturer.
 - If you install multiple memory devices into a multi card reader, you may experience problems.
6. If you use a USB extension cable, the USB device might not be recognized.

advanced functions

Supported Formats

	File Name	File extension	Bit Rate	Version	Pixel	Sampling Frequency
Still Picture	JPG	JPG JPEG	-	-	640*480	-
Music	MP3	.MP3	80~384kbps	-	-	44.1KHz
	WMA	.WMA	56~128kbps	V8	-	44.1KHz
Movie	DivX	.AVI, .ASF	4Mbps	.DivX3.11~DivX5, Xvid	720*480	44.1KHz~48KHz

Note

- VCD & WMV Can't be played on this player.

- CBI (Control/Bulk/Interrupt) is not supported.
- Digital Cameras that use PTP protocol or require additional program installation when connected to a PC are not supported.
- A device using NTFS file system is not supported. (Only FAT 16/32 (File Allocation Table 16/32) file system is supported.)
- Some MP3 players, when connected to this product, may not operate depending on the sector size of their file system
- The USB HOST function is not supported if a product that transfers media files by its manufacturer-specific program is connected.
- Does not operate with Janus enabled MTP(Media Transfer Protocol) devices.

CD Ripping

This feature lets you to copy audio files from disc to USB device into MP3 format.

1. Open the disc tray. Place The Audio CD(CD DA) disc on the tray, and close the tray. Connect the USB device to the USB port on the rear of the unit. Press ENTER to select the DISC.



2. With the unit in stop mode, press the **RETURN** button to display Ripping screen.
3. Press the **▲/▼** buttons to select the desired files, then press the **ENTER** button to marked files to be copying.
 - To unmarked copying all files press ENTER button again.



4. Press the **▶** buttons to select menu ripping **START**, then press the **ENTER** button.



Ripping Menu contains 4 buttons :

- Bit rate, press **ENTER** to change 128kbps → 192kbps → 128kbps...
- Device selection, press **ENTER** to change between devices (max 4)
- Select - Unselect, press **ENTER** to change from Select all or Select none.
- Start ripping, press **ENTER** to start ripping process

5. Press the **▲/▼** buttons to **START**, then press the **ENTER** button. File copy begins.
 - To cancel the copying in progress, press the **CANCEL** button.



Note

- To return to CDDA screen, press the **RETURN** button again.
- When the CD ripping is in process the player will automatically begin playing.
- Only Audio CD (CD DA) discs can be ripped.
- Because the speed is 2.6x of normal speed. User is unable to play the CD DA through the ripping process.

Picture CD Playback

1. Select the desired folder.
2. Press the ▲/▼ buttons to select a Picture file in the clips menu and then press the ENTER button.



Rotation

- Each time the ▲/▼ button is pressed, the picture rotates 90 degrees clockwise.

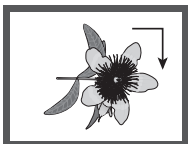

- Each time the ▲ button is pressed, the picture will reverse to the upside down to show a mirror image.

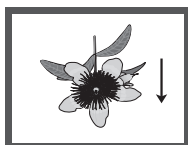

- Each time the ▼ button is pressed, the picture will reverse to the right side to show a mirror image.

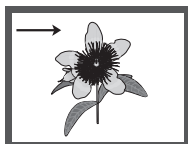

Slide show

- When you press the PLAY at JPEG file, it will go to full screen mode and automatically slide show.

Note

- Depending on the file size, the amount of time between each picture may be different from the set interval time.
- If you don't press any button, the slide show will start automatically in about 10 seconds by default.

MP3-JPEG Playback

You can play JPEG using music as a background.

1. Press the ▲/▼ buttons to select an MP3 file in the clips menu and then press the ENTER button.
2. Press the ▲/▼ buttons to select a JPEG file in the clips menu and then press the ENTER button.
 - Music will play from the beginning
3. Press Stop button when you want to stop the playback.

Note

- MP3 and JPEG files have to be on the same disc.

CD-R JPEG Disc

- Only files with the ".jpg" and ".JPG" extensions can be played.
- If the disc is not closed, it will take longer to start playing and not all of the recorded files may be played.
- Only CD-R discs with JPEG files in ISO 9660 or Joliet format can be played.
- The name of the JPEG file may not be longer than 8 characters and should contain no blank spaces or special characters (. / = +).
- Only a consecutively written multi-session disc can be played. If there is a blank segment in the multi-session disc, the disc can be played only up to the blank segment.
- A maximum of 3000 images can be stored on a single CD.
- Kodak Picture CDs are recommended.
- When playing a Kodak Picture CD, only the JPEG files in the pictures folder can be played.
- Kodak Picture CD: The JPEG files in the pictures folder can be played automatically.
- Konica Picture CD: If you want to see the Picture, select the JPEG files in the clips menu.
- Fuji Picture CD: If you want to see the Picture, select the JPEG files in the clips menu.
- QSS Picture CD: The unit may not play QSS Picture CD.
- If the number of files in 1 Disc is over 500, only 500 JPEG files can be played.
- If the number of folders in 1 Disc is over 500, only JPEG files in 500 folders can be played

advanced functions

Picture CD Playback for HD-JPEG

To enjoy HD-JPEG, HDMI must be connected and the resolution should be to 720p/1080i/1080p. Please set the HDMI as highest Resolution which your TV support.

1. Select the desired folder.



2. Press the ▲/▼ buttons to select a Picture file in the clips menu and then press the ENTER button.
- Press the STOP (■) button to return to the clips menu.
 - When Playing a Kodak Picture CD, the unit displays the Photo directly, not the clips menu.

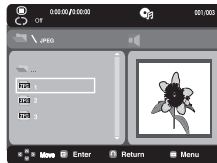

Note

- To make the setup menu disappear, press the MENU button.

- Rotation
Press the ◀▶ button to rotate the screen 90 degrees to the left/right.
- Skip Picture
Press the ◀◀ or ▶▶ button to select previous or next picture.
- Slide Show
Press the PLAY (▶) button to start SLIDE function.
Press the STOP (■) button to stop SLIDE function.

Note

- Depending on a file size, the amount of time between each picture may be different.
- The image may be displayed at a smaller size depending on the picture size when displaying images in HD-JPEG mode.
- It is recommended to set the "BD Wise" to "Off". In case of playback JPEG image file bigger than 720x480 pixel size.

changing setup menu

Using the Setup Menu

The Setup menu lets you customize your DVD player by allowing you to select various language preferences, set up a parental level, even adjust the player to the type of television screen you have.

1. Press the **MENU** button on the remote control. Use the **◀/▶** buttons to select Setup, then press the **▼** or **ENTER** button.

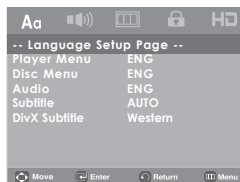

- 1 Language Setup Page: Setup of the Language.
 - 2 Audio Setup Page: Setup of the Audio Options.
 - 3 Display Setup Page: Setup of the Display Options. Use to select which type of screen you want to watch and several display options.
 - 4 Parental Page: Setup of the Parental Level. Allows users to set the level necessary to prevent children from viewing unsuitable movies such as those with violence, adult subject matter, etc.
 - 5 HDMI Page:
2. Press the **◀/▶** buttons to access the different features. Press the **▼** or **ENTER** button to access the sub features.
 3. To make the setup screen disappear after setting up, press the **MENU** button again.

Note

- On some discs, setup menu selections may not work.

Setting Up the Language Features

If you set the player menu, disc menu, audio and subtitle language in advance, they will come up automatically every time you watch a movie.

Using the Player Menu Language

1. Press the **MENU** button.
2. Press the **◀/▶** buttons to select **Language Setup Page**, then press the **▼** or **ENTER** button.
3. Press the **▲/▼** buttons to select **Player Menu**, then press the **▶** or **ENTER** button.
4. Press the **◀/▶** buttons to select the desired language, then press the **ENTER** button.
 - The language is selected and the screen returns to the Language Setup menu.
 - To make the setup menu disappear, press the **MENU** button.



Using the Disc Menu Language

1. Press the **MENU** button.
2. Press the **◀/▶** buttons to select **Language Setup Page**, then press the **▼** or **ENTER** button.
3. Press the **▲/▼** buttons to select **Disc Menu**, then press the **▶** or **ENTER** button.
4. Press the **◀/▶** buttons to select the desired language, then press the **ENTER** button.
 - The language is selected and the screen returns to the Language Setup menu.
 - To make the setup menu disappear, press the **MENU** button.



changing setup menu

Using the Audio Language

1. Press the **MENU** button.
2. Press the **◀/▶** buttons to select **Language Setup Page**, then press the **▼** or **ENTER** button.
3. Press the **▲/▼** buttons to select **Audio**, then press the **▶** or **ENTER** button.
4. Press the **◀/▶** buttons to select the desired language, then press the **ENTER** button.
 - Select “Original” if you want the default soundtrack language to be the original language the disc is recorded in.
 - If the selected language is not recorded on the disc, the original pre-recorded language is selected.
 - The language is selected and the screen returns to the Language Setup menu.
 - To make the setup menu disappear, press the MENU button.



Using the Subtitle Language

1. Press the **MENU** button.
2. Press the **◀/▶** buttons to select **Language Setup Page**, then press the **▼** or **ENTER** button.
3. Press the **▲/▼** buttons to select **Subtitle**, then press the **▶** or **ENTER** button.
4. Press the **◀/▶** buttons to select the desired language, then press the **ENTER** button.
 - Select “Automatic” if you want the subtitle language to be the same as the language selected as the audio language.
 - Some discs may not contain the language you select ; in that case the disc will use its original language setting.
 - The language is selected and the screen returns to the setup menu.
 - To make the setup menu disappear, press the MENU button.



Using the DivX Subtitle Language

1. Press the **MENU** button.
2. Press the **◀/▶** buttons to select **Language Setup Page**, then press the **▼** or **ENTER** button.
3. Press the **▲/▼** buttons to select **DivX Subtitle**, then press the **▶** or **ENTER** button.
4. Press the **◀/▶** buttons to select the desired language, then press the **ENTER** button.
 - The language is selected and the screen returns to the setup menu.
 - To make the setup menu disappear, press the MENU button.



Setting Up the Audio options

Audio Options allow you to setup the audio device and sound status settings depending on the audio system in use.

1. Press the **MENU** button.
2. Press the **◀/▶** buttons to select **Audio Setup Page**, then press the **▼** or **ENTER** button.
3. Press the **▲/▼** buttons to select the desired item, then press the **▶** or **ENTER** button.
 - To make the setup menu disappear, press the MENU button.

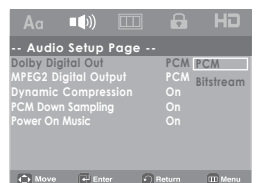
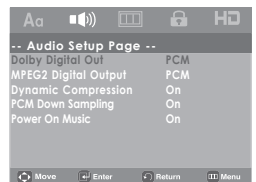

- ❶ **Dolby Digital Out**
 - PCM : Converts to PCM(2CH) audio.
 - Bit stream : Outputs Dolby Digital via digital output.
Select Bit stream when connecting to a Dolby Digital Decoder.

- ❷ **MPEG2 Digital Output**
 - PCM : Converts to PCM (2CH) audio.
 - Bit stream : Converts to MPEG-2 Digital Bit stream (5.1CH). Select Bit stream when using the Digital Audio Output.

Note
- When playing discs that have MPEG Audio in bit stream selection, the coaxial may not have any audio output. This depends on the AV receiver.

- ❸ **Dynamic Compression**
 - On : To select dynamic compression. This is useful for watching movies late at night, as it balances the loud and quiet portions of a disc.
 - Off : To select the standard range.
- ❹ **PCM Down Sampling**
 - On : Select this when the Amplifier connected to the player is not 96KHz compatible. In this case, the 96KHz signals will be down converted to 48KHZ.
 - Off : Select this when the Amplifier is connected to the player if it is 96KHz compatible. In this case, all signals will be output without any changes.

- ❺ **Power music on**
This menu is used to activate or deactivate the opening sound when you turn on the DVD player.
 - On : To turn On Start up music.
 - Off : To turn Off Start up music.

Note
- Even when PCM Down sampling is Off.
- Some discs will only output down sampled audio through the digital outputs.
- To make the setup menu disappear, press the MENU button.

HDMI
- If your TV is not compatible with compressed multi channel formats (Dolby Digital, DTS, MPEG), you should set Digital Audio to PCM.
- If your TV is not compatible with LPCM sampling rates over 48k Hz, you should set PCM Down sampling to on.

Manufactured under license from Dolby Laboratories. "Dolby" and the double-D symbol are trademarks of Dolby Laboratories.
"DTS" and "DTS Digital Out" are trademarks of Digital Theater Systems, Inc.

Setting Up the display options

Display options enable you to set various video functions of the player.

1. Press the **MENU** button.
2. Press the ◀/▶ buttons to select **Display Setup Page**, then press the ▼ or **ENTER** button.
3. Press the ▲/▼ buttons to select the desired item, then press the ▶ or **ENTER** button.
 - To make the setup menu disappear, press the **MENU** button.



- ❶ **TV Aspect**
Depending on a type of television you have, you may want to adjust the screen setting (aspect ratio).
 - 4:3 Pan&Scan : Select this for conventional size TVs when you want to see the central portion of the 16:9 screen. (Extreme left and right side of movie picture will be cut off.)
 - 4:3 Letter Box : Select when you want to see the total 16:9 ratio screen DVD supplies, even though you have a TV with a 4:3 ratio screen. Black bars will appear at the top and bottom of the screen.
 - 16:9 Wide : You can view the full 16:9 picture on your wide screen TV.

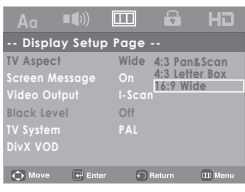

- ❷ **Screen Messages**
Use to turn on-screen messages On or Off.

changing setup menu

ⓐ Video Output

Select Video Output.

- I-SCAN : Select when you want to use Video and Component Interlace Out.
- P-SCAN : Select when you want to use Component Progressive Out or HDMI.

ⓑ Black Level

Adjusts the brightness of the screen (On or Off). It does not function in PAL mode.

ⓒ TV System

- NTSC : In case of using NTSC disc.
 - If your TV system only has PAL-Video input, you must choose "PAL". When you choose "PAL", Interlace output format is PAL 60 Hz output.
 - If your TV system only has NTSC, input you must choose "NTSC".
 - If you set up the NTSC TV, HDMI output frame rate is 60 Hz.
- PAL : In case of using PAL disc.
 - If your TV system only has NTSC-Video input, you must choose "NTSC". format is PAL 60 Hz output.
 - If your TV system only has PAL input, you must choose "PAL".
 - If you set up the PAL TV, HDMI output frame rate is 50 Hz

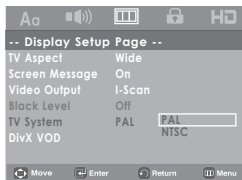

ⓓ DivX VOD

Select DivX VOD, then ► or ENTER button
Press OK to see the DivX Registration Number.

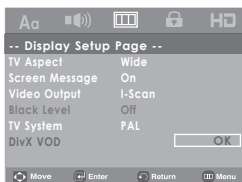

To make the setup menu disappear, press OK.

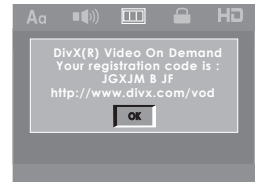

Note

- Consult your TV User's Manual to find out if your TV supports Progressive Scan. If Progressive Scan is supported, follow the TV User's Manual regarding Progressive Scan settings in the Tv's menu system.
- If Video Output is set incorrectly, the screen may be blocked.

Setting Up the parental control

Setting Up the Rating Level

The Parental Control function works in conjunction with DVDs that have been assigned a rating, which helps you control the types of DVDs that your family watches. There are up to 8 rating levels on a disc.

1. Press the **MENU** button.
2. Press the ◀/▶ buttons to select Parental Page, then press the ▼ or ENTER button.

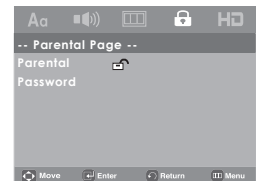

3. Press the ▲/▼ buttons to select the **Parental**, then press the ► or ENTER button.
4. Press the ▲/▼ buttons to select the Rating Level you want, then press the ENTER button.
e.g) Setting up in KID SAFE

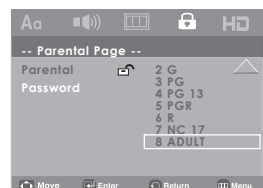

Note

- To make the setup menu disappear, press the MENU button.
For example, if you select the Kids Safe level, discs that contain level 2 or higher will not play.

- Fill in the blank box by pressing the ◀/▶/▲/▼ buttons to enter your password. By default, password is set to 0000.



Note

- ❶ KID SAFE
- ❷ G (General Audiences) : All Ages Admitted
- ❸ PG (Parental Guidance suggested) : Some material may not be suitable for young children.
- ❹ PG 13 (PG-13 Parents strongly cautioned) : Some material may be inappropriate for children under 13.
- ❺ PGR (Parental Guidance Recommended) : These are not necessarily unsuitable for children, but viewer discretion is advised, and parents and guardians are encouraged to supervise younger viewers.
- ❻ R (Restricted) : Under 17 requires accompanying adult
- ❼ NC17 (NC-17) : No one 17 and under admitted.
- ❽ ADULT

Changing the Password

- Press the MENU button.
- Press the ◀/▶ buttons to select **Parental Page**, then press the ▼ or ENTER button.

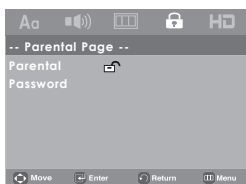

- Press the ▲/▼ buttons to select the **Password**, then press the ▶ or ENTER button.

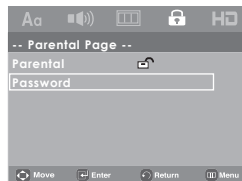

- Select Change, then press ENTER button.

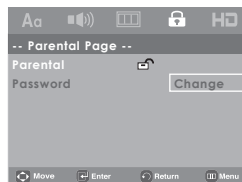

- Fill in the blank box by pressing the ◀/▶/▲/▼ buttons to enter your old password.



- Please change password to other than 0000 to activate parental control function. Enter your new password. Re-enter the new password again.

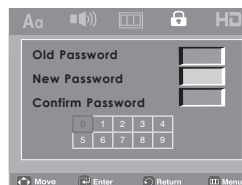

Note

- If you have forgotten your password, see "Forgot Password" in the Troubleshooting Guide.

changing setup menu

Setting Up the HDMI

This Setting is used when the unit is connected by HDMI to Display devices (TV, Projector, etc.).

1. Press the **MENU** button.
2. Press the **◀/▶** buttons to select **HDMI Page**, then press the **▼** or **ENTER** button.
3. Press the **▲/▼** buttons to select **HDMI**, then press the **▶** or **ENTER** button.
 - Auto : Auto resolution setting
 - 480p/576p : 720 x 480, 720 x 576
 - 720p : 1280 x 720
 - 1080i : 1920 x 1080
 - 1080p : 1920 x 1080

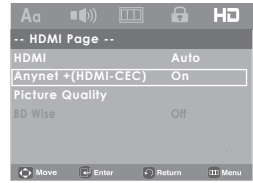

4. Set the Anynet+(HDMI-CEC) on "On" on your DVD Player., then press the **▶** or **ENTER** button.



5. Set the Anynet+ function on your Samsung TV. (See your TV instruction manual for more information).
 - When you press Anynet+ button on the TV remote control, the OSD to the right will appear.



Note

- The resolutions available for HDMI output depend on the connected TV or projector. For details, see the user's manual of your TV or projector.
- When the resolution is changed during playback, it may take a few seconds for a normal image to appear.
- If you have HDMI connected, better picture quality will be provided when the output resolution is set to 720p, 1080i or 1080p.

Setting Up Anynet+(HDMI-CEC)

Anynet+ is a function that can be used to operate this DVD Player using a Samsung TV remote control. This is done by connecting the DVD player to a SAMSUNG TV using an HDMI Cable. (see pages 11-12) This is only available with SAMSUNG TVs that support Anynet+.

1. Press the **MENU** button.
2. Press the **◀/▶** buttons to select **HDMI Page**, then press the **▼** or **ENTER** button.
3. Press the **▲/▼** buttons to select **Anynet+(HDMI-CEC)**, then press the **▶** or **ENTER** button.

You can operate the DVD Player by using the TV remote control. These are buttons that can be used to operate the DVD Player:



,  and  buttons, **0** ~ **9** buttons.

- Select Device : Use this option to select device which you want to connect to your TV.
- Menu on Device : Same as MENU button on the DVD Player remote control.
- Device Operation : Same as INFO button on the DVD Player remote control.

Note

- While watching TV, your TV screen will change to the play screen when you press the PLAY button of the DVD player.
- If you play a DVD when the TV power is off, the TV will power On.
- If you turn the TV off, the DVD player will power off automatically.
- If you change from HDMI to other sources (Composite, Component, ... etc) while a DVD Player will stop playing.

Setting Up Picture Quality

1. Press the **MENU** button.
2. Press the **◀/▶** buttons to select **HDMI Page**, then press the **▼** or **ENTER** button.
3. Press the **▲/▼** buttons to select **Picture Quality**, then press the **▶** or **ENTER** button.

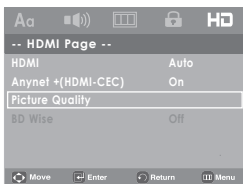

4. Press the **▲/▼** buttons to select **Picture Quality Page**, then press the **▶** or **ENTER** button.

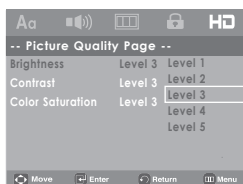

Note

- Brightness : Level 1 ~ Level 5
- Contrast : Level 1 ~ Level 5
- Color Saturation : Level 1 ~ Level 5

Setting Up BD Wise

When the player is connected to a SAMSUNG TV which supports "BD Wise", you can enjoy optimized Picture Quality by setting the "BD Wise" function as "On".

1. Press the **MENU** button.
2. Press the **◀/▶** buttons to select **HDMI Page**, then press the **▼** or **ENTER** button.
3. Press the **▲/▼** buttons to select **BD Wise**, then press the **▶** or **ENTER** button. Press the **▲/▼** buttons to select **On**, then press the **ENTER** button.

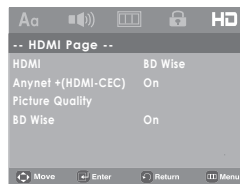
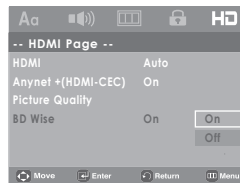
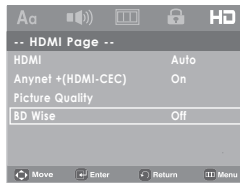

Note

- This option can be changed only when TV support BD Wise.

How to turn Off the BD Wise

If you wish to change to other resolution when "BD Wise On", Please choose a method between these two as follows :

Method 1

1. Press the **MENU** button.
2. Press the **◀/▶** buttons to select **HDMI Page**, then press the **▼** or **ENTER** button.
3. Press the **▲/▼** buttons to select **HDMI**, then press the **▶** or **ENTER** button. Press the **▲/▼** buttons to select resolution you wish to use, then press the **ENTER** button.

changing setup menu

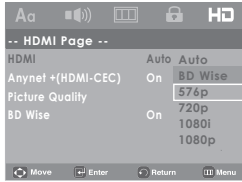

Note

- It is recommended to set the "BD Wise" to "Off". In case of playback JPEG image file bigger than 720x480 pixel size.

- Please choose "Yes" to continue, otherwise choose "No" to keep current setting.

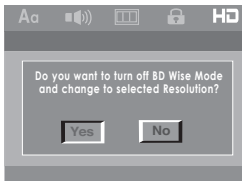

Method 2

1. Press the **MENU** button.
 2. Press the ◀/▶ buttons to select **HDMI Page**, then press the ▼ or **ENTER** button.
 3. Press the ▲/▼ buttons to select **BD Wise**, then press the ▶ or **ENTER** button. Press the ▲/▼ buttons to select **Off**, then press the **ENTER** button.
- The HDMI resolution will be changed to maximum resolution supported by your TV.

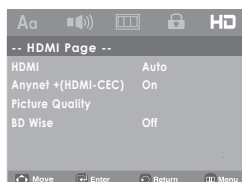
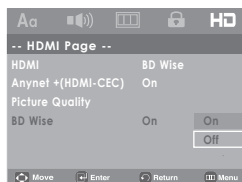
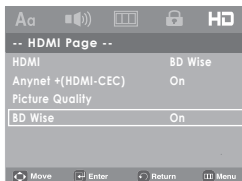

Firmware upgrade

Introduction

Samsung will often support the software upgrade to improve the performance of this unit to the latest status, through Samsung Internet Site (www.samsung.com).

Because the specially new mpeg4 codec continues and it is appearing. What improvements are made depends on the upgrade software you are using as well as the software that your DVD-player contained before the upgrade.

How to make an upgrade disc

Write the downloaded file onto a blank CD-R or CD-RW disc, using the following settings :

1. You have to download a new file through Download Center of Samsung Internet Site (www.samsung.com).
2. Write the file to Disc using CD-RW of your computer.

Note

- File system CD-ROM
- Character set ISO 9660
- Finalized, single session
- Write speed low

Upgrade procedure

1. Open the disc tray of your DVD-Player.
Place the burned disc on the tray. Close the tray.
The Firmware upgrade screen will appear.

```
Upgrade file detected
Current version: 07.01.03.08.H1080XAA
Update version: 07.02.03.09.H1080XAA
Upgrade ?
Press Play to start
```

Firmware upgrade
menu appears

2. Press enter or play upgrade
 - Press any other button on the remote control to cancel the upgrade and eject the discs (eg. ▲ etc).appear.

```
Upgrade file detected
Current version: 07.01.03.08.H1080XAA
Update version: 07.02.03.09.H1080XAA
Upgrade ?
Press Play to start
File copying
```

Firmware upgrade
starts

```
Upgrade file detected
Current version: 07.01.03.08.H1080XAA
Update version: 07.02.03.09.H1080XAA
Upgrade ?
Press Play to start
Upgrade
```

Firmware upgrade
menu starts

- During the firmware upgrade process, the tray will open. Please remove the disc and wait for about 2 minutes.
 - If the DVD player was successfully updated, the disc tray will close and the unit will turn off and on. When the unit turns on, the Select Menu Language screen will appear.
3. Press the ▲/▼ buttons to select the desired language, and then press the ENTER button.





Note

- If the “Select Menu Language” doesn’t appear, please contact Samsung Customer Service.
- Do not press any button or unplug the power cord during the upgrade.
- The upgrade procedure may change, refer to the web site (www.samsung.com).

Troubleshooting

Before requesting service (troubleshooting), please check the following.

Problem	Action	Page
No operations can be performed with the remote control.	<ul style="list-style-type: none"> • Check the batteries in the remote control. They may need replacing. • Operate the remote control at a distance of no more than 20 feet. • Remove batteries and hold down one or more buttons for several minutes to drain the microprocessor inside the remote control to reset it. Reinstall batteries and try to operate the remote control again. 	P3
Disc does not play.	<ul style="list-style-type: none"> • Ensure that the disc is installed with the label side facing up. • Check the region number of the DVD. 	P5
The  icon appears on screen.	<ul style="list-style-type: none"> • The features or action cannot be completed at this time because: <ol style="list-style-type: none"> 1. The DVD's software restricts it. 2. The DVD's software doesn't support the feature (e.g., angles). 3. The feature is not available at the moment. 4. You've requested a title or chapter number or search time that is out of range. 	
Disc Menu doesn't appear	<ul style="list-style-type: none"> • Check if the disc has a Menu 	
Play mode differs from the Setup Menu selection.	<ul style="list-style-type: none"> • Some of the functions selected in the Setup Menu may not work properly if the disc is not encoded with the corresponding function. 	P27-33
The screen ratio cannot be changed.	<ul style="list-style-type: none"> • The Screen Ratio is fixed on your DVDs. 	P29-30
No audio.	<ul style="list-style-type: none"> • Make sure you have selected the correct Digital Output in the Audio Options Menu. 	P28-29
The screen is blocked	<ul style="list-style-type: none"> • Press the  button (on the front panel) for more than 5 seconds with no disc inside. All settings will revert to the factory settings 	P15
Forgot password	<ul style="list-style-type: none"> • Press the  button (on the panel) for more than 5 seconds with no disc inside. All settings including the password will revert to the factory settings. Don't use this unless absolutely necessary. 	P30-31
If you experience other problems.	<ul style="list-style-type: none"> • Go to the contents and find the section of the instruction book that contains the explanations regarding the current problem, and follow the procedure once again. • If the problem still cannot be solved, please contact your nearest authorized service center. 	
The picture is noisy or distorted	<ul style="list-style-type: none"> • Make sure that the disc is not dirty or scratched. • Clean the disc. 	P2
No HDMI output.	<ul style="list-style-type: none"> • Check the Video output is HDMI enabled. • Check the connection between the TV and the HDMI jack of DVD player. • See if the TV supports this 480p/576p/720p/1080i/1080p DVD player 	P11-12
Abnormal HDMI output screen.	<ul style="list-style-type: none"> • If snow noise appears on the screen, it means that TV does not support HDCP (High-bandwidth Digital Content Protection). 	P11-12
HDMI output Jitter	<ul style="list-style-type: none"> • Check your TV system setup correctly. • The screen Jitter phenomenon may occur when frame rate is converted from 50Hz to 60Hz for 720P/1080i/1080p HDMI (High Definition Multimedia Interface) Output. • Please refer to the user's manual of your TV. 	P32-33

Specifications

General	Power Requirements	AC 110-240V ~ 50/60 Hz
	Power Consumption	8 W
	Weight	0.976 Kg
	Dimensions	264.5mm (W) X 248mm (D) X 50.5mm (H)
	Operating Temperature Range	+5°C to +35°C
	Operating Humidity Range	10 % to 75 %
Disc	DVD (DIGITAL VERSATILE DISC)	Reading Speed : 3.49 ~ 4.06 m/sec. Approx. Play Time (Single Sided, Single Layer Disc) : 135 min.
	CD : 12Cm (COMPACT DISC)	Reading Speed : 4.8 ~ 5.6 m/sec. Maximum Play Time : 74 min.
	CD : 8Cm (COMPACT DISC)	Reading Speed : 4.8 ~ 5.6 m/sec. Maximum Play Time : 20 min.
Video Output	Composite Video	1 channel : 1.0 Vp-p (75 Ω load)
	Component Video	Y : 1.0 Vp-p (75 Ω load) Pr : 0.70 Vp-p (75 Ω load) Pb : 0.70 Vp-p (75 Ω load)
	HDMI	480p/576p. 720p. 1080i. 1080p
Audio Output	Maximun Output Level	2Vrms
	Digital Audio Output	Coaxial terminal (S/PDIF)
	*Frequency Response	20Hz~20kHz

*: Nominal specification

Note

- Samsung Electronics Co., Ltd reserves the right to change the specifications without notice.
- Weight and dimensions are approximate.



UNITED KINGDOM

This Samsung product is warranted for the period of twelve (12) months from the original date of purchase, against defective materials and workmanship. In the event that warranty service is required, you should return the product to the retailer from whom it was purchased.

However, Samsung Authorised Dealers and Authorised Service Centres in other EC Countries will comply with the warranty on the terms issued to purchasers in the country concerned.

In case of difficulty, details of our Authorised Service Centres are available from:

Samsung Electronics U.K. Ltd.
Customer Care Centre PO Box 17243 Edinburgh,
EH11 4YB United Kingdom

United Kingdom

Tel : 0845 SAMSUNG (7267864)

Fax : 0845 650 8080

Web : www.samsung.com

EIRE

Tel : 0818 717 100

Fax : +44 (0)131 202 0630

Web : www.samsung.com

■ WARRANTY CONDITIONS

1. The warranty is only valid if, when warranty service is required, the warranty card is fully and properly completed and is presented with the original invoice or sales slip or confirmation, and the serial number on the product has not been defaced.
2. Samsung's obligations are limited to the repair or, at its discretion, replacement of the product or the defective part.
3. Warranty repairs must be carried out by Authorised Samsung Dealers or Authorised Service Centres. No re-imbursment will be made for repairs carried out by non Samsung Dealers and, any such repair work and damage to the products caused by such repair work will not be covered by this warranty.



EIRE

4. This product is not considered to be defective in materials nor workmanship by reason that it requires adaptation in order to conform to national or local technical or safety standards in force in any Country other than the one for which the product was originally designed and manufactured. This warranty will not cover, and no re-imbursment will be made for such adaptation nor any damage which may result.
5. This warranty covers none of the following:
 - a) Periodic check ups, maintenance and repair or replacement of parts due to normal wear and tear.
 - b) Cost relating to transport, removal or installation of the product.
 - c) Misuse, including the failure to use this product for its normal purposes or incorrect installation.
 - d) Damage caused by Lightning, Water, Fire, Acts of God, War, Public Disturbances, incorrect mains voltage, improper ventilation or any other cause beyond the control of Samsung.
6. This warranty is valid for any person who legally acquired possession of the product during the warranty period.
7. The consumers statutory rights in any applicable national legislation whether against the retailer arising from the purchase contract or otherwise are not affected by this warranty. Unless there is national legislation to the contrary, the rights under this warranty are the consumers sole rights and Samsung, its subsidiaries and distributors shall not be liable for indirect or consequential loss or any damage to records, compact discs, videos or audio taper or any other related equipment or material.

SAMSUNG ELECTRONICS (U.K.) LTD.

Contact SAMSUNG WORLD WIDE

If you have any questions or comments relating to Samsung products, please contact the SAMSUNG customer care center.

Region	Country	Contact Center ☎	Web Site
North America	CANADA	1-800-SAMSUNG(726-7864)	www.samsung.com/ca
	MEXICO	01-800-SAMSUNG(726-7864)	www.samsung.com/mx
	U.S.A	1-800-SAMSUNG(726-7864)	www.samsung.com/us
Latin America	ARGENTINE	0800-333-3733	www.samsung.com/ar
	BRAZIL	0800-124-421, 4004-0000	www.samsung.com/br
	CHILE	800-SAMSUNG(726-7864)	www.samsung.com/cl
	NICARAGUA	00-1800-5077267	www.samsung.com/latin
	HONDURAS	800-7919267	www.samsung.com/latin
	COSTA RICA	0-800-507-7267	www.samsung.com/latin
	ECUADOR	1-800-10-7267	www.samsung.com/latin
	EL SALVADOR	800-6225	www.samsung.com/latin
	GUATEMALA	1-800-299-0013	www.samsung.com/latin
	JAMAICA	1-800-234-7267	www.samsung.com/latin
	PANAMA	800-7267	www.samsung.com/latin
	PUERTO RICO	1-800-682-3180	www.samsung.com/latin
	REP. DOMINICA	1-800-751-2676	www.samsung.com/latin
TRINIDAD & TOBAGO	1-800-SAMSUNG(726-7864)	www.samsung.com/latin	
VENEZUELA	0-800-100-5303	www.samsung.com/latin	
Europe	COLOMBIA	01-8000112112	www.samsung.com.co
	BELGIUM	02 201 2418	www.samsung.com/be
	CZECH REPUBLIC	800-726-786 (800 - SAMSUNG)	www.samsung.com/cz
	DENMARK	70 70 19 70	www.samsung.com/dk
	FINLAND	030-6227 515	www.samsung.com/fi
	FRANCE	3260 SAMSUNG (€ 0,15/Min) 08 25 08 65 65 (€ 0,15/Min)	www.samsung.com/fr
	GERMANY	01805 - SAMSUNG(726-7864 € 0,14/Min)	www.samsung.de
	HUNGARY	06-80-SAMSUNG(726-7864)	www.samsung.com/hu
	ITALIA	800-SAMSUNG(726-7864)	www.samsung.com/it
	LUXEMBURG	02 261 03 710	www.samsung.com/lu
	NETHERLANDS	0900-SAMSUNG (726-7864 € 0,10/Min)	www.samsung.com/nl
	NORWAY	815-56 480	www.samsung.com/no
	POLAND	0 801 801 881, 022-607-93-33	www.samsung.com/pl
	PORTUGAL	80820-SAMSUNG(726-7864)	www.samsung.com/pt
	SLOVAKIA	0800-SAMSUNG(726-7864)	www.samsung.com/sk
	SPAIN	902-1-SAMSU(72678)	www.samsung.com/es
	SWEDEN	0771-400 200	www.samsung.com/se
	U.K	0845 SAMSUNG (7267864)	www.samsung.com/uk
	EIRE	0818 717 100	www.samsung.com/ie
	AUSTRIA	0800-SAMSUNG(726-7864)	www.samsung.com/at
SWITZERLAND	0800-SAMSUNG(726-7864)	www.samsung.com/ch	
CIS	RUSSIA	8-800-555-55-55	www.samsung.ru
	KAZAKHSTAN	8-10-800-500-55-500	www.samsung.com/kz_ru
	UZBEKISTAN	8-10-800-500-55-500	www.samsung.com/kz_ru
	KYRGYZSTAN	00-800-500-55-500	
	TADJIKISTAN	8-10-800-500-55-500	
	UKRAINE	8-800-502-0000	www.samsung.ua
	LITHUANIA	8-800-77777	www.samsung.lt
	LATVIA	8000-7267	www.samsung.com/lv
	ESTONIA	800-7267	www.samsung.ee
	AUSTRALIA	1300 362 603	www.samsung.com/au
Asia Pacific	NEW ZEALAND	0800 SAMSUNG (0800 726 786)	www.samsung.com/nz
	CHINA	800-810-5858, 400-810-5858, 010-6475 1880	www.samsung.com/cn
	HONG KONG	3698-4698	www.samsung.com/hk
	INDIA	3030 8282, 1800 110011, 1-800-3000-8282	www.samsung.com/in
	INDONESIA	0800-112-8888	www.samsung.com/id
	JAPAN	0120-327-527	www.samsung.com/jp
	MALAYSIA	1800-88-9999	www.samsung.com/my
	PHILIPPINES	1800-10-SAMSUNG(726-7864)	www.samsung.com/ph
	SINGAPORE	1800-SAMSUNG(726-7864)	www.samsung.com/sg
	THAILAND	1800-29-3232, 02-689-3232	www.samsung.com/th
	TAIWAN	0800-329-999	www.samsung.com/tw
	VIETNAM	1 800 588 889	www.samsung.com/vn
Middle East & Africa	TURKEY	444 77 11	www.samsung.com/tr
	SOUTH AFRICA	0860-SAMSUNG(726-7864)	www.samsung.com/za
	U.A.E	800-SAMSUNG (726-7864), 8000-4726	www.samsung.com/ae



Correct Disposal of This Product



(Waste Electrical & Electronic Equipment)
(Applicable in the European Union and other European countries with separate collection systems)

This marking on the product, accessories or literature indicates that the product and its electronic accessories (e.g. charger, headset, USB cable) should not be disposed of with other household waste at the end of their working life. To prevent possible harm to the environment or human health from uncontrolled waste disposal, please separate these items from other types of waste and recycle them responsibly to promote the sustainable reuse of material resources.

Household users should contact either the retailer where they purchased this product, or their local government office, for details of where and how they can take these items for environmentally safe recycling.

Business users should contact their supplier and check the terms and conditions of the purchase contract. This product and its electronic accessories should not be mixed with other commercial wastes for disposal.

Correct disposal of batteries in this product



(Applicable in the European Union and other European countries with separate battery return systems.)

of with other household waste at the end of their working life. Where marked, the chemical symbols Hg, Cd or Pb indicate that the battery contains mercury, cadmium or lead above the reference levels in EC Directive 2006/66. If batteries are not properly disposed of, these substances can cause harm to human health or the environment.

To protect natural resources and to promote material reuse, please separate batteries from other types of waste and recycle them through your local, free battery return system.

